

DIMENSIONI - DIMENSION - DIMENSIONS - BAUGROSSEN

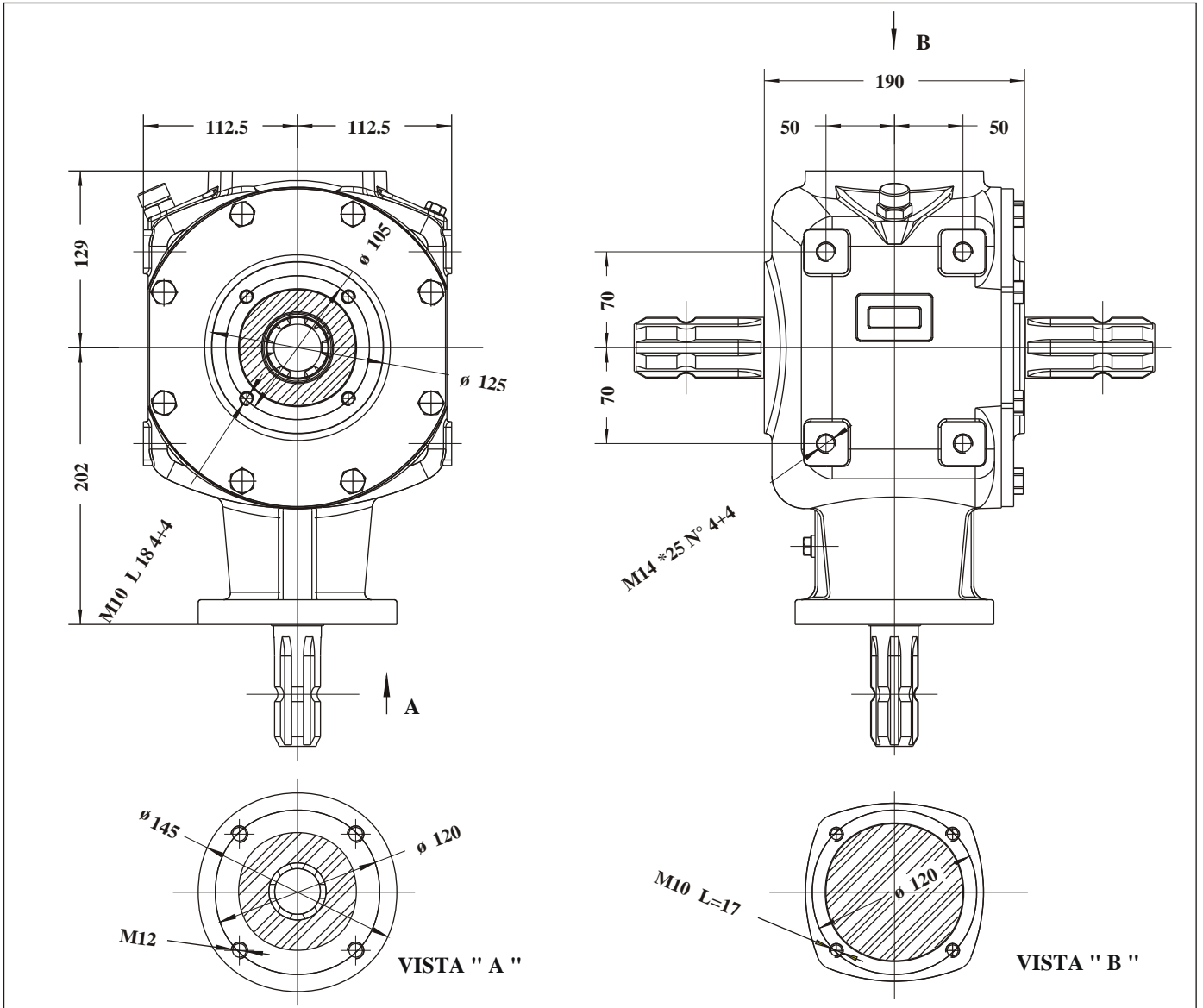

	MASSA MASS MASSE	Kg.30
	LUBRIFICANTE LUBRICANT LUBRIFIANT SCHMIERSTOFF	SAE 90 EP 1.8 Lt.

CONFIGURAZIONI - CONFIGURATION - CONFIGURATIONS - BAUFORMEN

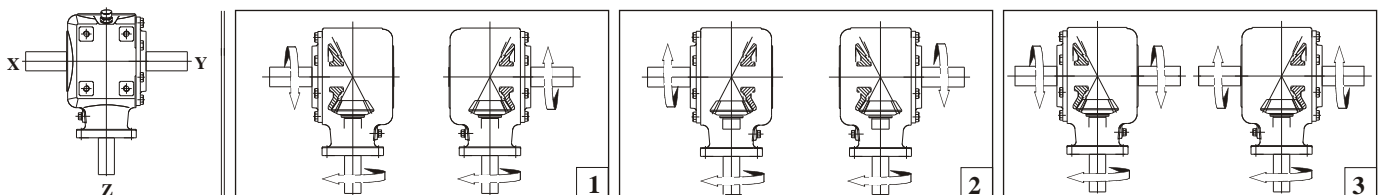

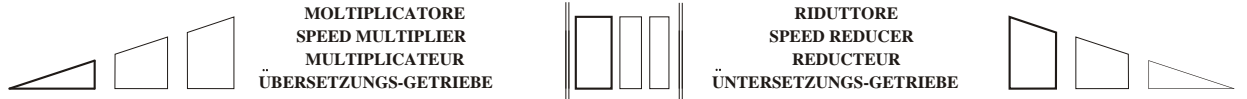

MOLTIPLICATORE
SPEED MULTIPLIER
MULTIPLICATEUR
ÜBERSETZUNGS-GETRIEBE

RIDUTTORE
SPEED REDUCER
REDUCTEUR
ÜNTERSETZUNGS-GETRIEBE

Rapporto Ratio Rapport Übers.-verh.	1:5.33	1:4.08	1:3.08	1:2.58	1:1.92	1:1	1.92:1	2.58:1	3.08:1	4.08:1	5.33:1
Giri - r.p.m. U/min	540 1000	540 1000	540 1000	540 1000	540 1000	540 1000	540 1000	540 1000	540 1000	540 1000	540 1000
Kw	- -	59 90	55 83	68 102	80 120	- -	49 75	34 53	24 38	20 27	- -
HP	- -	80 123	75 113	93 139	109 163	- -	67 102	47 72	33 52	27 37	- -
DaNm	- -	106 88	100 81	123 100	144 117	- -	89 73	62 52	44 37	36 27	- -

▲ Elicoidale - Helicoidal - Helicoidale - spiralverzahnung

DURATA STIMATA A 540 giri/min - ESTIMATED LIFE AT 540 rpm - DUREE DE VIE ESTIMEE A 540 Tours/m - LEBENSDAUER ca. 540 U/min

